

Rainbow SE

AquaMate®

Carpet Cleaning Extraction Unit



A revolutionary new method of carpet cleaning which gives professional results and leaves your carpets beautifully clean.

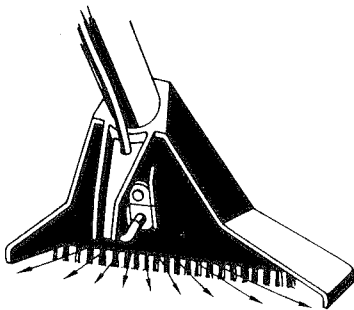

SPRAYS SOLUTION INTO CARPET

Power sprays cleaning
solution deep into carpet



EASY TO USE

No special equipment needed
Hook up to your Rainbow

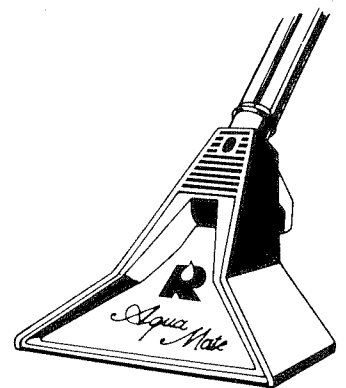

RAINBOW POWER REMOVES MOISTURE

Rainbow's wet pickup feature*,
plus high volume air flow
removes moisture from carpet.

The configuration of the Rainbow Cleaning System and the words Rainbow®, Rexair® and AquaMate® are registered trademarks of Rexair, Inc.

*Refer to your Rainbow Operation Manual to verify wet pickup capability.

AQUAMATE CARPET CLEANING FORMULA

AquaMate's unique Carpet Cleaning Formula combines ease of operation, superior cleaning results, and economy.

CLEANS
DEODORIZES

RECONDITIONS
PROTECTS

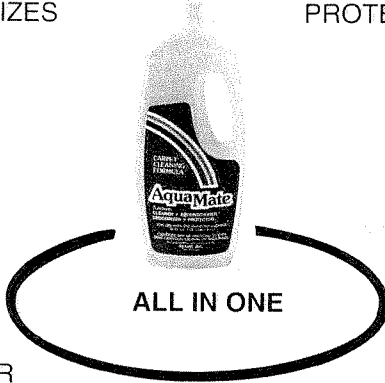

- **CLEANER**
Powerful cleaner for removing most stains and loosening embedded dirt.
- **RECONDITIONER**
Helps remove residual detergents from previous shampooing.
- **DEODORIZER**
Leaves carpets fresh and clean smelling.
- **PROTECTOR**
Conditions carpet with a protective coating to help guard against resoiling.

WARNING

The AquaMate by Rexair, Inc., is designed to be used with the Rainbow model numbers D2A, D3 (All Models), D4 (All Models). Model numbers can be verified on the nameplate on the inside of the Rainbow main housing. Should you still have any further questions, please contact your registered Rainbow distributor. **Do not** use the AquaMate with a Rainbow that is not listed above.

ANY OTHER USAGE MAY RESULT IN SEVERE ELECTRICAL SHOCK.

IMPORTANT SAFEGUARDS

ONLY USE THE RAINBOW HOSE WITH THE AQUA-MATE. DO NOT ATTEMPT TO USE THE ELECTRIFIED HOSE.

Please read and follow all instructions concerning hazards of electricity outlined in your Rainbow Operation manual.

PLEASE NOTE: The AquaMate Cleaning Solution has been specially formulated for optimum cleaning results when used with the AquaMate. Other cleaning solutions on the market will leave a gummy residue resulting in rapid resoiling of the carpet, and could damage your AquaMate.

SET-UP

1. Insert Rainbow hose into the water basin of your Rainbow unit. **Water basin should be empty before starting to clean.** Please also refer to wet pickup instructions in the back of your Rainbow Operation Manual.
2. Attach extension wands and control assembly together.
3. Attach extraction head to base of the extension wands.
4. Push the thin tube into retainer slots on the back side of the extension wands.
5. Thread thin tube through hole in lower hose storage hook.
6. Push the end of the thin tube over the spray nozzle on the extraction head.
7. Attach Rainbow hose to the end of bent wand.

WARNING: To avoid risk of electrical shock, **NEVER** use the electrified hose (supplied with the Power Nozzle) to pick up water or any other fluids. Use **only** the Rainbow hose, supplied with the Rainbow, for wet-pickup operations. Refer to Rainbow manual for illustrations and descriptions of each hose.

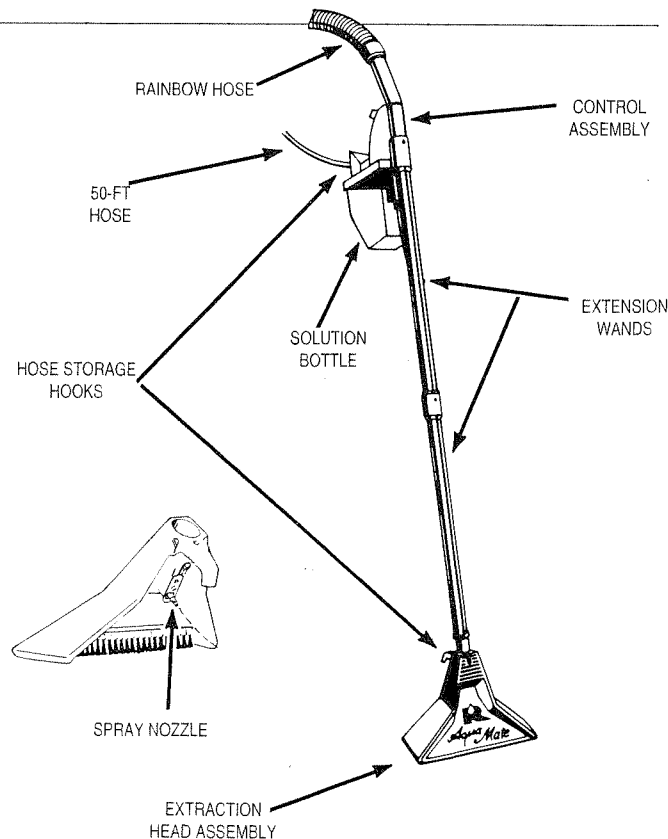

OPERATION

FAUCET ATTACHMENT INSTRUCTIONS

1. Preparation: First, vacuum carpet thoroughly. Then you are ready to use your AquaMate.
2. Attach the water hose to any threaded kitchen or bathroom faucet. Some faucets have external threads and others have internal threads. Most have aerators or screen filters that unscrew. Unscrew the aerator. If pliers are necessary, wrap the aerator with tape to avoid damage. If an adapter is necessary, screw it to the faucet (refer to instruction sheet included in adapter package). Screw the water hose to the adapter. This should be done carefully and slowly to avoid damaging threads. If you must connect to a laundry type thread, an adapter can be purchased separately. There are also adapters available that will attach to threadless faucets called Pos-A-Grip adapters.

FAUCET WITH THREADS ON INSIDE

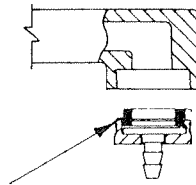

USE BOTH THICK AND THIN WASHERS

FAUCET WITH THREADS ON OUTSIDE

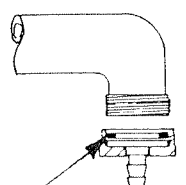

USE THIN WASHER ONLY

SOLUTION BOTTLE ATTACHMENT INSTRUCTIONS

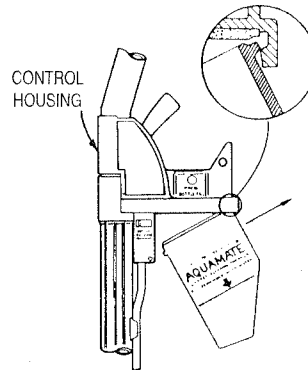

1.

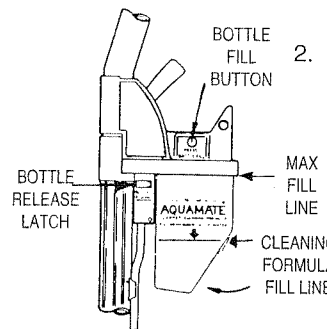

2.

1. Hook lip on top rear side of bottle over ledge in rear underside of control housing.

2. Pivot bottle forward. Bottle release latch will snap lock the bottle in position.

3. Set your faucet between warm and cold. **Hot water could damage the system and carpet.** Run water prior to attaching hose to avoid cold water start. A washer is provided on the hose to prevent drips.
4. Remove the solution bottle by sliding the bottle release latch in the direction of the arrow. Pour AquaMate Carpet Cleaning Formula to the fill line. **Note:** AquaMate Carpet Cleaning Formula can be purchased from your registered Rainbow distributor.
5. Reattach the solution bottle to the control housing. (Follow the solution bottle attachment instructions shown at right.)
6. Depress the bottle fill button on the side of the control housing. This will dispense clean water into the solution bottle. Fill the bottle until the water level is even with the side of the control housing. Refer to maximum fill line shown at right: **DO NOT OVERFILL.**
7. Set the mode selector on the side of the control housing to "wash."
8. Plug in the Rainbow electrical cord to a wall receptacle and you are ready to clean your carpets.
9. Prior to cleaning room, heavily soiled areas should be prespotted. This can be done by releasing cleaning solution spray with the release trigger, holding the wand approximately six inches over the heavily soiled areas. This operation can be done without the Rainbow running, using only the water pressure from your faucet. Once you have prespotted the heavily soiled areas, you can proceed to clean the entire room as directed.

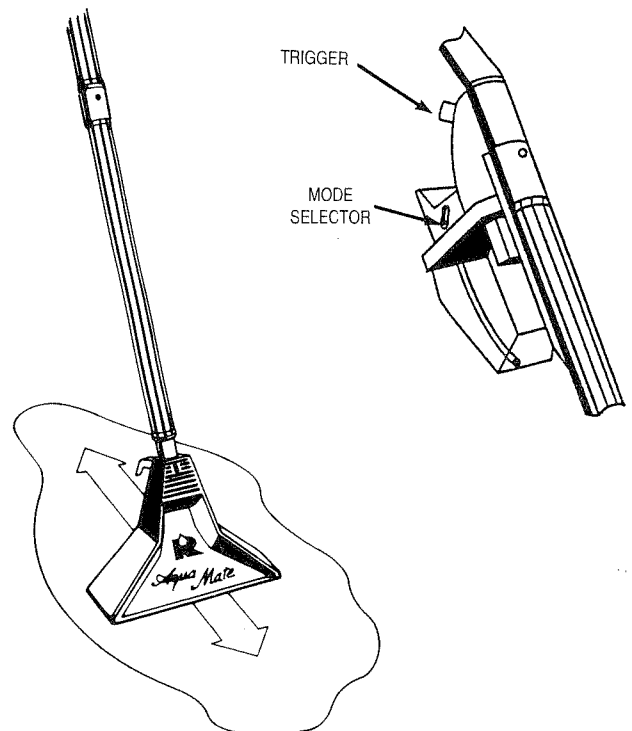

10. Turn on power by the off-on switch on the Rainbow unit.
11. Place the extraction head on the carpet and with one hand engage the injector trigger, release the spray of cleaning solution and warm water into your carpet. Pull the unit toward you so that the Rainbow picks up the dirty water.
12. Back and forth scrubbing will help loosen spots. Prespot traffic areas with quick initial pass, then clean entire room.
13. Areas that have been cleaned with the cleaning solution may be rinsed. This is done by switching the mode selector on the side of the control housing to "rinse."
14. A final pass over the carpet with the AquaMate will help the carpet dry faster. Faucet or water supply should be turned off.
15. **Each time you refill the solution bottle, you should empty the liquid waste in the Rainbow water basin.** Water pickup capacity of the Rainbow unit is two quarts. Additional volume beyond the two quarts will cause your Rainbow to overload. **If the Rainbow unit begins to make noise or rock, turn unit off immediately and empty water basin.**
16. When finished with the cleaning job, clean the water basin and wands before storing. Rinse the parts with water. Follow the instructions for flushing the system listed below. To dry the wands and the hose, attach hose to the exhaust end of the Rainbow unit for 5 to 10 minutes. Please refer to proper care for long life of the Rainbow as outlined in the Rainbow Operation Manual.

IMPORTANT FLUSHING THE SYSTEM

The AquaMate carpet cleaning solution contains a carpet protector to prevent resoiling. This carpet protector solution can clog the small orifices in the AquaMate if the unit is not properly rinsed after each use.

Follow these instructions exactly before storing your AquaMate:

1. Empty the remaining carpet cleaning solution from the solution bottle.
2. Rinse the solution bottle and fill part way with clear water.
3. Reattach solution bottle and set the mode selector to the "wash" position.
4. Pull trigger and run clear water through the AquaMate to flush the system.
5. Leave the mode selector in the "wash" position during storage. **DO NOT** store with the mode selector in the "Rinse" position.
17. When unit is clean and dry, store water hose on hooks provided.
18. When carpet is thoroughly dry, vacuum to comb nap.

TROUBLE SHOOTING

1. Trouble:
Unit stops spraying or stops injecting cleaning solution.
2. Possible cause:
 - No water pressure
 - Obstruction in tube
 - Obstruction in spray nozzle
3. Remedy:
 - Check faucet to be sure you still have water pressure supplied to the unit.
 - Check the spray nozzle on the extraction head. Clean off any build-up. Pull off tube and run clean-out tool through hole if necessary.
 - Check the solution bottle. Pull off flow control adapter at end of thin tube. Clean out small hole if plugged.
4. To Clean Spray Nozzle:
A nozzle clean-out tool is provided. See below.

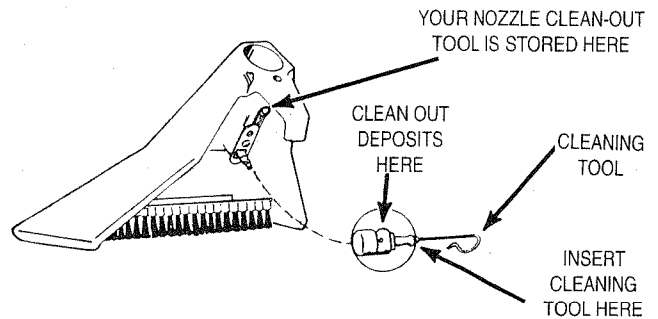

YOUR LOCAL REGISTERED
RAINBOW DISTRIBUTOR

For any additional information or assistance, please first contact your local registered distributor or write to:

REXAIR, INC
3221 W. Big Beaver, Suite 200
Troy, Michigan 48084