

MESSAGE FROM REXAIR

Rexair sells the **Rainbow** Cleaner only to independent Authorized Distributors who are experienced in direct in-the-home selling. Since Rexair does not market its product through national advertising, awareness of the product is created by the individual efforts of thousands of direct selling "dealers," who, by means of in-home demonstrations create interest in the **Rainbow** Cleaner in their local communities. The independent Authorized Distributors with whom those dealers are affiliated assume the responsibility for the legitimate distribution and service of the **Rainbow** Cleaner directly through their own dealers, or indirectly through independent subdistributors and their dealers.

Rexair further requires that each Authorized Distributor make prompt and workmanlike service available through its own service outlets or through responsible independent service outlets in those communities in which it sells Rexair products through its independent subdistributors and dealers.

Do not lose the name and address of the Dealer or Distributor from whom you bought the **Rainbow** Cleaner. Contact him or her for advice on caring for your **Rainbow**, warranty coverage, service, and the nearest service outlet.

Rexair is highly selective regarding those it appoints as its direct customers, the Authorized Distributors. However, Rexair has no agreement or legal relationship with the independent resellers who acquire products directly or indirectly from an Authorized Distributor, and can only attempt to correct any customer complaints about such resellers by acting through the responsible Authorized Distributor. Rexair's announced policy is to hold each Authorized Distributor responsible for remedying the results of any statement or action by any of the independent resellers that may result in a complaint from any member of the buying public.

Should you have any problem or have any question regarding the above, you should first contact the Distributor or Dealer from whom you purchased your **Rainbow**. If you have any problem locating that person, contact Rexair's Customer Service Department at the address listed below, being sure that you include your **Rainbow's** Serial Number. They will immediately send you the name, address and phone number of the responsible Authorized Distributor for your area. If you feel you are not receiving proper assistance from the Authorized Distributor, please contact us immediately. All of our Authorized Distributors know their obligations.

For any additional information or assistance write to:

Rexair, 50 W. Big Beaver Road, Suite 350, Troy, Michigan 48084, U.S.A.
(248) 643-7222 or fax to (248) 643-7676. You can visit Rexair's Web Site at:

www.RainbowSystem.com

Rexair provides to its Authorized Distributors, and only to them, a written four-year warranty on its vacuum cleaner and attached accessories and an eight-year warranty on the vacuum cleaner motor and controller. Replacement parts can be new or remanufactured as provided at Rexair's sole discretion. These warranties do not cover normal wear-and-tear arising from usage of the products. Even though Rexair, as the manufacturer, does not deal directly with the consumer nor provide the consumer with a written warranty, the law imposes certain responsibilities on all manufacturers who make consumer products. The products must not be defective and must be generally fit for their intended uses. These implied warranties of merchantability and fitness are honored by Rexair. Further, Rexair requires each Authorized Distributor to pass through to the consumer, by way of the Authorized Distributor's own written warranty, the benefit of Rexair's warranty to such Distributor.

Rexair sells the Rainbow to its Authorized Rainbow Distributors for resale by those Distributors and their agents solely through in-home demonstrations to ultimate user-owners. Any other sale is strictly prohibited. Any product purchased in any other sale is not covered by the authorized warranties.

WRITTEN WARRANTY

**Owner's Manual
Power Nozzle
e SERIES**

**Please read all
instructions
carefully before
using unit.**

TABLE OF CONTENTS

Important Safety Instructions..... 2
 Using Your Power Nozzle 3
 Electrified Hose 4
 Replacing a Worn Belt..... 5
 Trouble-Shooting 6
 Message from Rexair / Warranty Back Cover

CUSTOMER CARE NUMBER

As part of Rexair's Consumer Care program, all new Rainbow Power Nozzles receive a Consumer Care Serial Number after passing Quality Control testing at the factory. This serial number provides:

1. Ownership Identification for you;
2. Warranty Identification for your distributor;
3. Assurance of passing Quality Control testing;
4. Assurance of "factory-fresh" condition.

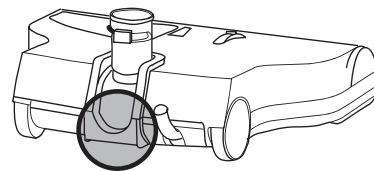

For your protection, check to see that the serial number is on the Rainbow Power Nozzle at the location shown on the accompanying diagram. No new Rainbow Power Nozzle should be sold without this number. If the number is missing, Rexair makes no claim as to the origin, age, or condition of the unit. If you cannot find a serial number on your Rainbow Power Nozzle, please call our customer service department at (248) 643-7222, or fax to (248) 643-7676. For additional information or assistance, please write to: Rexair 50 W. Big Beaver Road, Suite 350, Troy, Michigan 48084 U.S.A.

For your own protection, record the serial number in the space provided below.

Save this information for future reference.



Visit Rexair's Web Site at: www.RainbowSystem.com

Your Authorized Rainbow Distributor

(Please Print)

Name: _____

Address: _____

City/State/Zip: _____

Phone: _____

Dealer Signature: _____

Serial No.: _____

The configuration of the **Rainbow**® Cleaning System and the words **Rainbow**®, **RainbowMate**® and **Rexair**® are registered trademarks of Rexair, Troy, Michigan U.S.A.

PROBLEM	POSSIBLE CAUSE	POSSIBLE SOLUTION
Motor Not Running.	Handle switch not activated.	Must squeeze actuator in electrified hose handle.
	Electrical connection at hose coupling not made.	Make positive electrical connection at opening.
	Electrical connection at hose handle not made.	Make positive electrical connection at hose handle.
	Automatic resetting motor protector has tripped.	Turn Rainbow off. Leave off for two seconds. Turn Rainbow back on.
Motor Running But Brush Not Revolving.	Broken belt.	Disconnect power; Remove sole plate; Make sure brush rotates freely; Replace belt.
Brush Stopped (Cannot Be Rotated By Hand).	Object lodged in brush chamber.	Disconnect power; Remove sole plate; Remove foreign object; Make sure brush rotates freely.
	Bearing worn out.	Replace brush and bearing assembly by Distributor.
Power Nozzle Not Picking Up Well.	Clogged air chamber.	Disconnect power; Remove sole plate; Clear out entire air chamber; Sight through pivot arm to make sure there are no obstructions.
	Clogged wands or hose.	Disconnect power; Remove obstruction; Connect to Rainbow; Make sure air is flowing freely through hose.
	Bristles not in contact with carpet.	Make sure sole plate is completely in position before latching; Replace brush if bristles are worn too short.
	Height adjustment not properly set.	Set to proper height.

TROUBLE-SHOOTING

This Rainbow appliance was thoroughly tested and inspected at the factory. If a minor problem develops, the following troubleshooting procedures may help identify and correct the problem with a minimum inconvenience.

If the above solutions do not prove successful, call your Authorized Rainbow Distributor.

REPLACING A WORN BELT

NOTE:
Always disconnect unit from electrical supply when servicing.

NOTE:
Contact your local Rainbow distributor for a new Power Nozzle belt. Store the new belt in the spare belt pocket under the sole plate.

- 1 **NOTE:** Always disconnect from electrical supply when servicing. Turn the Power Nozzle upside down. Using a flat-bladed screwdriver or coin, turn the fastener a quarter-turn to the left (counterclockwise). Remove the sole plate by grasping the finger tabs.

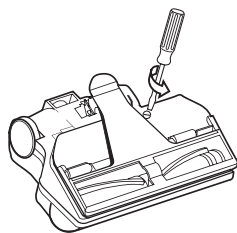

- 2 **Insert Finger Under Belt Cover Near The Brush.**
Lift the belt cover to unlatch it and rotate it back towards the wand.

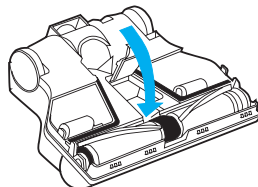

- 3 **To remove the brush roll,** grasp the outermost ends of the brush roll and lift the brush roll out of the pockets in the nozzle housing. Remove the worn or broken belt from the brush roll or the motor shaft.

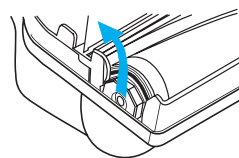

- 4 **Loop the new belt around the pulley in the center of the brush roll.** Position the brush roll over the unit so that indicator groove is nearest the spare belt pocket and the belt is hanging from the brush roll near the motor shaft. Position the belt around the motor shaft.

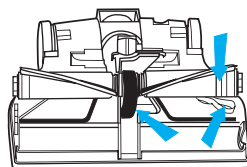

- 5 **With the belt looped around the motor shaft and pulley in the center of the brush roll, position the ends of the brush roll on the rails located at the outboard edges of the Power Nozzle.** Using both hands, slide the brush roll on the rails towards the front of the unit until the ends of the brush roll are fully seated into their pockets. Spin the brush roll by hand until the belt tracks in the center of the pulley on the brush roll.

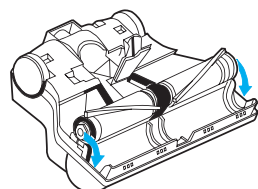

- 6 **Rotate the belt cover towards the front of the unit and push down to snap it into place.**

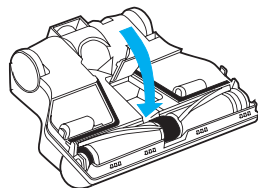

- 7 **Position the sole plate over the unit.** Snap into place edge of the sole plate into the unit and turn the fastener a quarter-turn to the right (clockwise) until it "clicks."

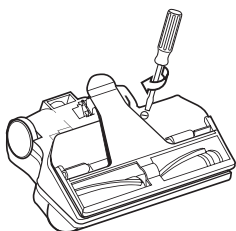

WARNING: TO REDUCE THE RISK OF FIRE, ELECTRIC SHOCK OR INJURY:

- 1 Close supervision is necessary when any appliance is used by or near children. Do not allow your Rainbow to be used as a toy or to run unsupervised at any time.
- 2 Unplug the Rainbow when not in use. Turn it off at the master switch before unplugging. Grasp the plug to disconnect it from the wall outlet to avoid damage to cord, plug, prongs or receptacle. Do not pull or carry by cord, use cord as a handle, close a door on cord, pull or carry around sharp edges or corners. Do not run appliance over cord. Keep cord away from heated surfaces. Do not use with damaged cord or plug.
- 3 Do not leave appliance when plugged in. Unplug Rainbow from outlet when unattended and before servicing.
- 4 If Rainbow or Power Nozzle is in disrepair, do not attempt to operate either machine. If the Rainbow is not working properly as it should, has been dropped, damaged, left outdoors or dropped into water, return it to your Rainbow Distributor.
- 5 Do not clean the unit or unclog the hose until the Rainbow is switched off and the plug is removed from the wall outlet.
- 6 Do not connect to the receptacle of an incandescent light fixture or use any extension cords.
- 7 To avoid the possibility of fire or explosion, do not use your Power Nozzle in areas where flammable and/or explosive vapor or dust is present. Some cleaning fluids can produce such vapors. Areas where flammable cleaning fluids have been used should be completely dry and thoroughly aired before being vacuumed. Do not use the Rainbow or Power Nozzle to unplug drains. If sewer gas is drawn into the Rainbow, it could cause an explosion.
- 8 Never touch a metal sink, cold or hot water pipe with one hand while touching the metal parts of any electrical appliance, light fixture or switch with the other hand. Your body could complete an electrical circuit to the ground. Additionally, wet skin surfaces can greatly increase this hazard. Do not handle plug or appliance with wet hands.
- 9 (a) Do not put any objects into openings; Do not use with any openings blocked; Keep free of dust, lint, hair and anything that may reduce airflow; (b) Keep hair, loose clothing, fingers and all parts of the body from openings and moving parts; (c) Use extra care when cleaning on stairs.
- 10 Type Y power cords must be replaced by an authorized Rainbow distributor. If the cord is damaged, turn off the power switch on the Rainbow and unplug the unit.
- 11 Do not pick up anything that is burning or smoking, such as cigarettes, matches or hot ashes. Do not use to pick up flammable or combustible liquids, such as gasoline, or use in areas where they may be present.
- 12 This appliance is provided with double insulation. Use only identical replacement parts. See instructions for Servicing of Double-Insulated appliances in Rainbow Owner's Manual.
- 13 Your Power Nozzle contains a powerful revolving brush. To avoid bodily injury, the Power Nozzle should not be placed against or close to loose clothing, jewelry, hair or body surfaces while cleaner is connected to electrical outlet. The Power Nozzle does NOT protect against bodily injury or damage to objects that contact the revolving brush.
- 14 **WARNING: The electrified hose contains electric wires. To reduce the risk of electric shock: Do not immerse. Do not use or repair a damaged hose. Use only on carpet moistened by cleaning process.**
- 15 **IMPORTANT: The electrified hose contains electrical wires and should be checked regularly. Do not use if damaged, cut, or punctured. Avoid picking up sharp objects. Do not use to suck up water. Do not immerse in water for cleaning. Always turn off this appliance before connecting or disconnecting either the hose or motorized nozzle.**

IMPORTANT SAFETY INSTRUCTIONS

Please read all instructions before using unit. Use your Rainbow only for its intended use as described in the instructions. The use of attachments not recommended by Rexair may cause hazards.

ALWAYS FOLLOW THESE IMPORTANT SAFETY INSTRUCTIONS.

SAVE THESE INSTRUCTIONS

FOR HOUSEHOLD USE ONLY

USING YOUR POWER NOZZLE

Use the Power Nozzle and RainbowMate for dry pick-up only. To avoid risk of electrical shock, NEVER pick up water or any other fluids with the Power Nozzle or RainbowMate.

ASSEMBLY:

- 1 Push straight wand into pivot arm of the motorized powerhead unit.
- 2 Insert the electric cord into the long cord channel guide on straight wand by pressing the cord into channel guide with thumb.
- 3 Leave a bit of slack in the lower cord at the base of the straight wand (and pivot arm) to enable the handle to be raised and lowered.

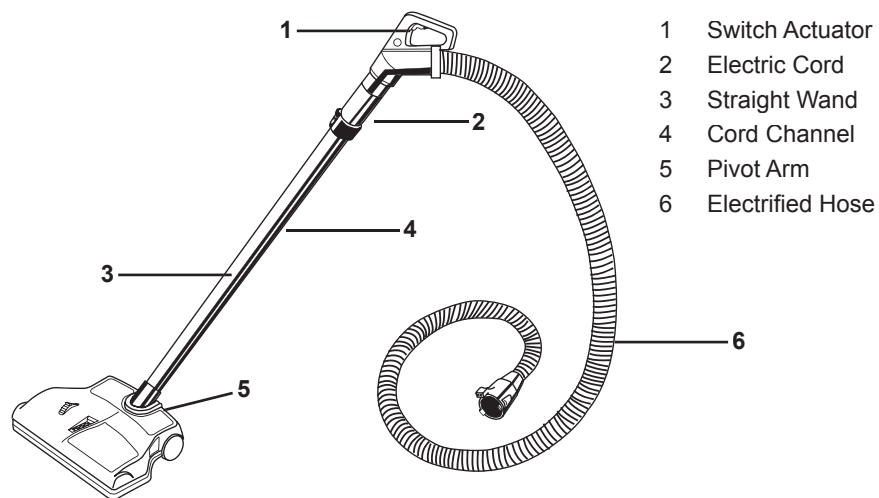

1 OPERATING THE POWER NOZZLE:

Hold the Power Nozzle. Squeeze the switch actuator and slowly guide the Power Nozzle back and forth in smooth and easy strokes. Let the Power Nozzle and the Rainbow Cleaner do the work.

Adjust The Power Nozzle For Proper Height

The Power Nozzle has a three-position height adjustment to meet virtually any carpet cleaning need. The HEIGHT adjustment is made by turning the three-position thumb wheel located on the top side of the Power Nozzle to the desired selection.

LOW: For most carpets and rugs.

MEDIUM: For pusher carpeting where Power Nozzle may drag.

HIGH: For very deep pile carpeting and special applications.

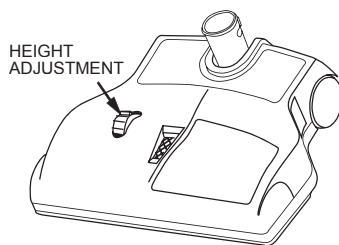

2 LOCK POWER NOZZLE IN UPRIGHT POSITION:

To lock the Power Nozzle wand in the upright position, place left foot on top of the Power Nozzle. Grasp the straight Power Nozzle wand and push forward until the wand is fully engaged in the locking tabs. To disengage the Power Nozzle wand, follow these same steps in the reverse order.

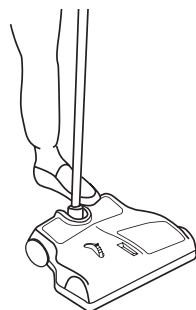

- 1 **CONNECTING POWER NOZZLE WAND AND ELECTRIFIED HOSE HANDLE:** Insert the short metal wand of the Rainbow handle on the electrified hose into the long metal wand of the Power Nozzle. Align the button lock on the short wand with the guide on the Power Nozzle wand. Slide the button into the guide to engage the lock. When button lock engages, connection is secure.

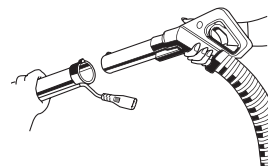

- 2 **MAKING THE ELECTRICAL CONNECTION:** Holding hose firmly (do not grip Rainbow handle switch actuator), plug the Power Nozzle electric cord into the receptacle on the underside of the Rainbow handle.

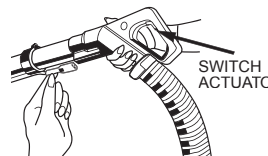

- 3 **CONNECTING ELECTRIFIED HOSE TO POWER UNIT:** Attach the electrified hose to the front of the power unit at the air inlet opening. Insert the coupling end into the air inlet opening, open the receptacle door by lifting up with the top of the hose coupling, and press the coupling into the machine until both latches have snapped into place. This will complete the electrical connection to the machine.

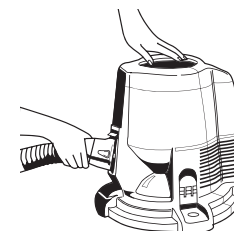

- 4 **ENERGIZING THE POWER NOZZLE:** With the electrical connections made, the power unit master switch will energize both the power unit and the Power Nozzle. However, the power unit will not activate the power nozzle brush roll. The switch actuator in the Rainbow handle must be actuated to operate the Power Nozzle. To remove the electrified hose from the power unit, squeeze coupling side latches and pull hose from intake opening.

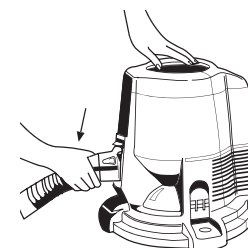

- 5 After the electrical connections are made, push the ON/OFF switch on the Rainbow to the "high-speed" setting (>>) to operate both the Rainbow and the motorized Power Nozzle. The switch in the electrified hose handle will operate the Power Nozzle only. To remove the electrified hose from the lower unit, squeeze coupling side latches and pull hose from intake opening.

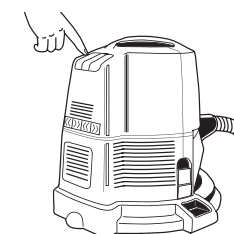

SERVICE INFORMATION: PLEASE READ VERY CAREFULLY.

The performance of your new cleaner greatly depends upon home maintenance. The instructions given in this booklet will guide you in performing simple home maintenance. To obtain the most satisfying years of service, read through these instructions and keep them handy for future reference.

- Never pick up hard or sharp objects with the Rainbow. Items such as pins, hairpins, tacks, crayons, and pencil stubs may damage the brush roll or break a belt.
- DO NOT OIL MOTOR. The motor is permanently lubricated and sealed.
- Use Power Nozzle on carpeting and/or large floor rugs only.
- **DO NOT USE ON BARE OR HARDWOOD FLOORS.**
- **Use on dry surfaces only. Do not use outdoors or on wet surfaces.**

ELECTRIFIED HOSE

WARNING: The electrified hose contains electric wires. To reduce the risk of electric shock: Do not immerse. Do not use or repair a damaged hose. Use only on carpet moistened by cleaning process.